



# ADHYAY

Volume 10 Edition 1





# DEPARTMENT OF ELECTRONICS ENGINEERING

## VISION

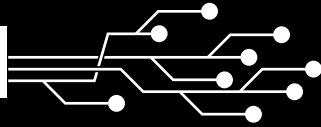

"Department of Electronics & Computer Science (E&CS) will strive to achieve academic excellence in electronics and electronics related technical education in University of Mumbai to develop internationally competent professionals with a sense of responsibility and social sensitivity."

## MISSION

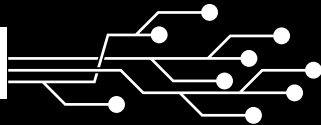

To achieve academic excellence by creating the right ambience for nurturing and enhancing personal as well as professional skills that will enable students to compete globally.

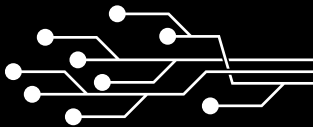

## PROGRAM SPECIFIC OUTCOMES

**PSO1:** To clearly understand the concepts and applications in the field of Electronics such as semiconductor technology, signal processing, embedded systems, communication etc. and acquire skills to Identify, formulate & solve problems in related fields of Electronics.

**PSO2:** To design electronics and computer-based components and systems for applications including signal processing, communication and control systems with the capability to comprehend the technological advancements with the help of modern design tools to analyze and design subsystems/processes for a variety of applications.

**PSO3:** To understand the impact of engineering solutions in a Global, Economic, Environmental, and Societal context and co-relate the learning to derive solutions to real world problems.

**PSO4:** To demonstrate skills to communicate in verbal and written form effectively and demonstrate the practice of professional ethics along with the concerns for societal and environmental wellbeing.

# A MESSAGE FROM THE HOD

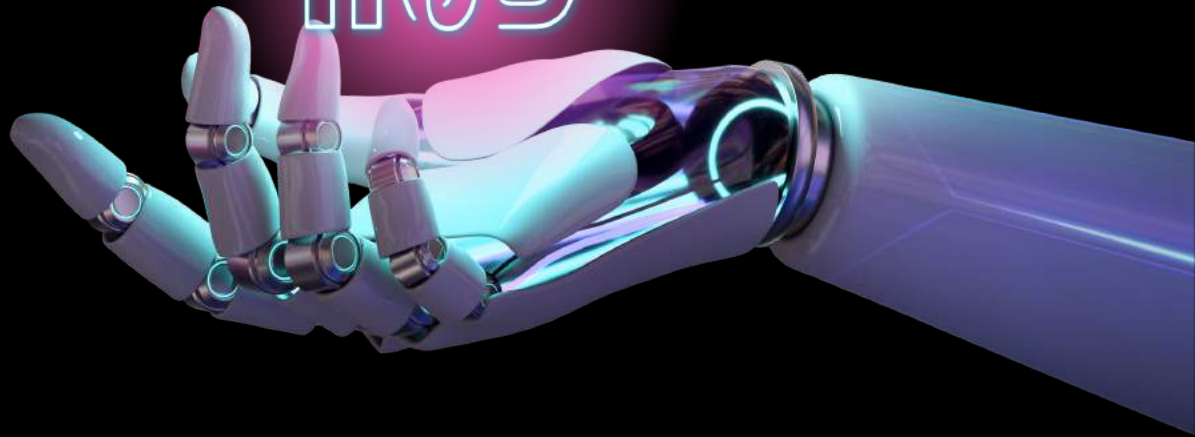

## DR. S.C. PATIL



The Electronics & Communication Engineering is one of the most dynamically changing and ever evolving branch since more than 100 years. Electronics is the foundation on which Information Technology and Computer Engineering has grown. Engineering with the latest tools such as VLSI Design, MATLAB , ARM CORTEX, LAB View, FPGA Board, to make students Industry ready. All high-speed networks and computers work on the hardware designed by electronic engineers. 21st century is the century of

communication as communication engineering has been growing exponentially in recent years. At TCET, department of electronics Institute developed state-of-art laboratories & centers of excellence so as to train our students in Electronics Engineering through flexible, adaptive and progressive training programs, Bridge Courses, Various project in signal System and communication Domain and other Domains along with cohesive interaction with the research organizations, academicians and industries and having experience faculties in the department. It is my pleasure to work with imminent students who eager to develop the carrier in Electronics Engineering.

# A MESSAGE FROM THE FACULTY INCHARGE

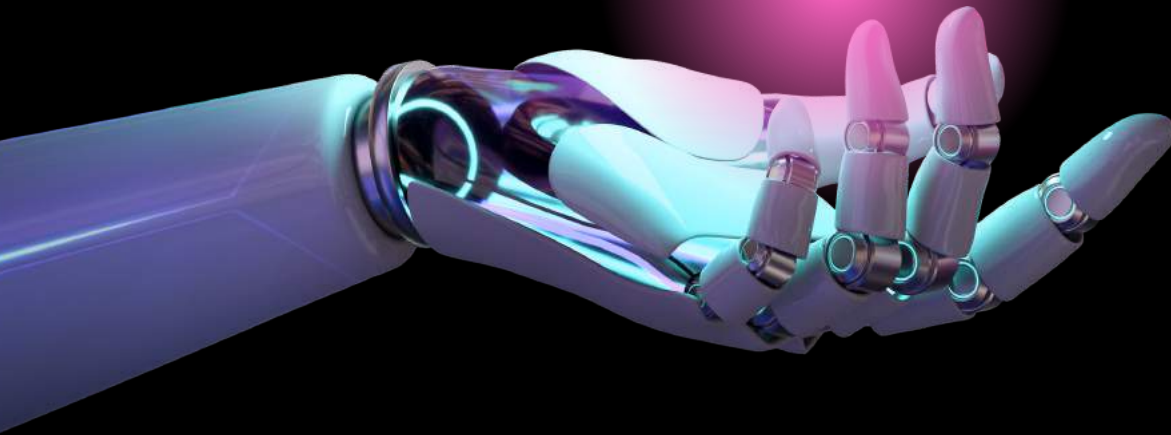

## SUMIT KUMAR

Education is about awakening –Awakening to the power and beauty that lies within all of us. To my mind education as an idea, is not just about bricks ,mortar and concrete , but about building character , enriching minds and about varied experiences that last a lifetime. vision is to give the students the all round capability including creativity ,observation and knowledge empowerment leading to the generation of excellent ,performing citizens with sterling character.



The RICRAC acronym is used to remind students & parents “Responsibility , Integrity, Caring , Respectful , Academic and Cooperative”. These values , we believe , will enable our students to take a leadership role in learning and in life.

There is a commitment to an integrated curriculum approach through inquiry learning. The development of higher order thinking skills, risk taking ,adaptability, cooperation, and communication techniques are fostered.

provide a platform to its students to showcase their inborn talents. We also take utmost care in moulding our children as responsible global citizen.

We would like to see them soar to new heights and taste success in all their endeavors. We are convinced that the education’s purpose is to replace an empty mind with an open one.

I expect sincere cooperation from parents and guardians for the attainment of school’s objectives.



# A MESSAGE FROM THE IETE FACULTY INCHARGE



## ARCHANA BELGE



As in today's world only bookish knowledge is not sufficient to stand oneself in the competitive world, we the Department of Electronics Engineering at TCET believe in overall development. We take care of the holistic development of students along with technical growth. We train students through various activities like Activity Based Learning (ABL); Project Based Learning (PBL); In-house Internship Programs, Workshops on upcoming technology and many more activities. In ABL we encourage students to

develop their personality through various activities like debate, extempore, group discussions etc. In PBL students are guided to prepare projects by identifying real world problems and applying computing fundamental and technical skill to find solution to them. In house Internship Programs are where students learn different coding languages which makes them industry competent... Professional Body activities are specially planned to make students ready for their professional career, through various activities like Workshops in looming technologies, Seminars, hands-on session up to date trend in Electronics, software and hardware in different platforms, industrial visits at various places to understand the upcoming requirements in industries. Professional Body is formed by the students for the students. Electronics Department Faculty believes in Great teachers. "The mediocre teacher tells. The good teacher explains. The superior teacher demonstrates. The great teacher inspires." – William A. Ward

# WORDS OF WISDOM



**SUJATA ALEGAVI (ASSOCIATE PROFESSOR)**



Excellence is never an accident, it is a result of high intension, sincere effort, intelligent direction, sincere effort, skillful execution, and the vision to see obstacles as opportunities.



**SUNIL KHATRI (ASSISTANT PROFESSOR)**

There are always people who just work hard and people who work hard smartly. In order to rise above all other competitors, your approach to any problem should be in a systematic manner so that there's clarity regarding what to do and with the extent of priority to be given as well. Hence my words of wisdom to all students are - "Be smart in your work methodology & set your priorities straight".

**LEENA CHAKRABORTY (ASSISTANT PROFESSOR)**



As a teacher, we do not only see our self as having the responsibility to teach and impart knowledge about different subject matters to our students; but, We also strive to motivate them to aspire to achieve excellence, and the best in whatever they do. Education is not a safety net. It is the rocket which will propel you towards success. All you have to do is have an aim and work on everything that takes to get a lift-off.



**JALPABEN PANDYA (ASSISTANT PROFESSOR)**

Education is not concerned with any ideology, nor is it based on any system, neither is it a mean of conditioning the individual in some special manner. Education in its true sense is helping the individual to be mature and free, to flower greatly in love and goodness. The highest function of education is to bring about an integrated individual who is capable of dealing with life as a whole.

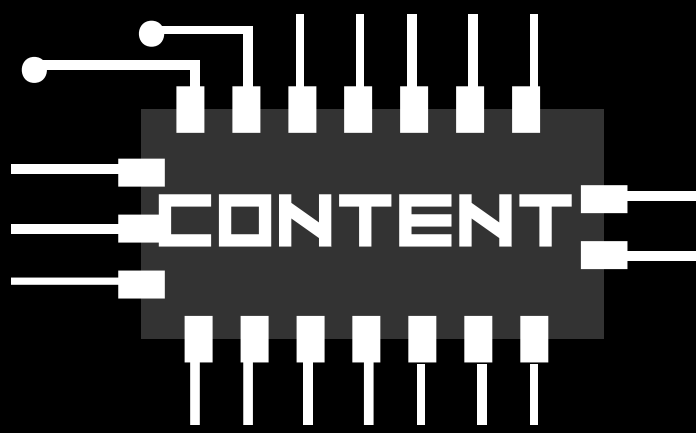

---

STUDENTS ARTICLE ④

INTERVIEW ③

RESEARCH PAPER ④

ROBOTICS ③

---

## STUDENT ARTICLES

---

- MONITOR ARMS IN 2022 .....9
- Smart Home .....11
- Viral Marketing: Science Of Arresting The Human Intelligence.....12
- Web-3.0 .....14

---

## RESEARCH PAPER

---

- Science of Supernova.....23
  - IoT Fire Detection and Retardation For Passenger Trains.....25
  - SHREE – A SMART WATCH.....27
  - Self Propelled Battery Management System in Electric Vehicles.....30
-



# STUDENT ARTICLES

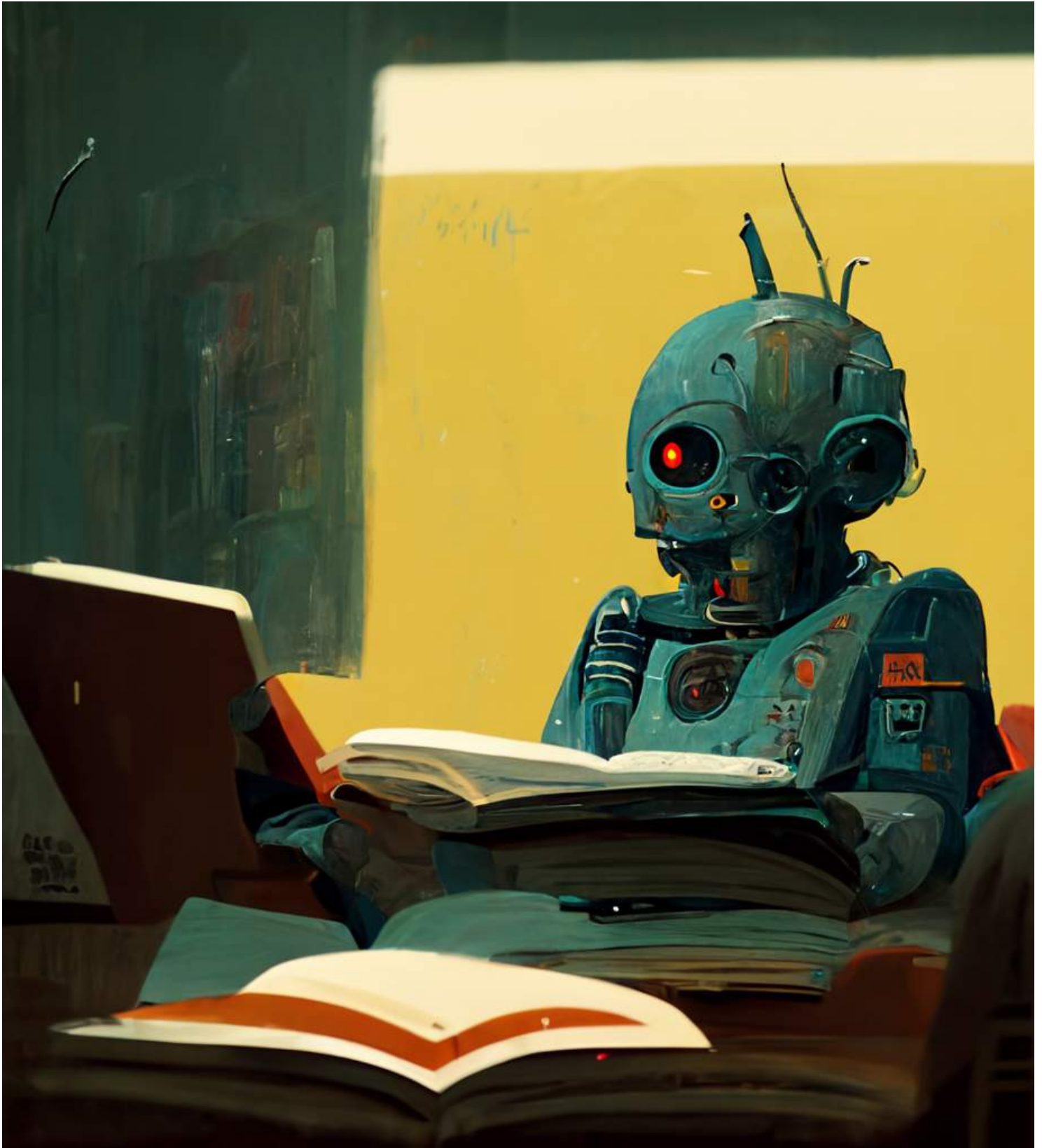

# MONITOR ARMS IN 2022

"IT HAS BECOME APPALLINGLY OBVIOUS THAT OUR TECHNOLOGY HAS EXCEEDED OUR HUMANITY." - ALBERT EINSTEIN

- Sakshi Porwal (TE ELEX)

As you can decode from the word, Monitor Arms, sounds like some device that acts as an arm, and is a monitor. Yes, you are right. An arm length that is away from you, works in your replacement, just by taking your position on the desk and hunching over like you do.

"Monitor Arms in 2022" has become advanced enough that it allows you to easily rotate your screen vertically so you can view your work from another angle.

Monitor Arms are not that difficult to understand, they are the customizable devices that work on the principle of providing a counterweight on the monitor's base.



## IMPORTANCE OF A MONITOR ARM: AN ERGONOMIC ECOSYSTEM.

When paired with other ergonomic items, like a split keyboard and mouse and an adjustable desk or an ergonomic chair, monitor arms are an essential part of any ergonomic ecosystem.

With your screen at the proper distance, you'll experience less pain in your neck and back, and you'll reduce your risks of developing Computer Vision Syndrome (CVS) — a condition caused by overuse and improper screen distance.

## WHY DO YOU NEED A MONITOR ARM?

If you are working on a laptop or desktop, spending one-third or more than that of your day over there, then you are shortening your age by

yourself, you must know how your body must be rested. Typing on your laptop necessitates that you keep it on your desk. This means you'll have to look down at your screen, which puts pressure on your spine. Monitor arms are the solution for the same. That's how you seen observe side effects of sitting and working before the screen are and how you can find a solution for it



## IMPORTANCE OF A MONITOR ARM: AN ERGONOMIC ECOSYSTEM.

When paired with other ergonomic items, like a split keyboard and mouse and an adjustable desk or an ergonomic chair, monitor arms are an essential part of any ergonomic ecosystem. With your screen at the proper distance, you'll experience less pain in your neck and back, and you'll reduce your risks of developing Computer Vision Syndrome (CVS) — a condition caused by overuse and improper screen distance. That's how you seen observe side effects of sitting and working before the screen are and how you can find a solution for it.



There are different types of Monitor Arms with different technologies and benefits available, let us name a few.

**1. Amazon Basics Single Monitor Stand:** The best monitor arm for people who only need the basics. Single monitor arm adjusts effortlessly for easy use. Arm extends and retracts, tilt to change reading angles. The Price goes around 5,000 INR.

**2. NB North Bayou Monitor Desk Mount Stand:** The best budget monitor arm. Display and keyboard lift distance, easily and simultaneously lift keyboard and LCD screen to proper height, let you swing your display left, right, up and down with full range of motion provide unsurpassed ergonomic comfort. The price goes around 2000 INR.

**3. Fully Jarvis Monitor Arm:** The best overall monitor arm. Constantly looking down at your monitor collapses the natural forward curve of your neck vertebrae and compresses the disks in between. The Price ranges around 10,000 INR.

But not only this, there are a number of benefits you have by using monitor arms. Have a look over them:

**1. Eliminate computer eye strain:** If you've been working at the computer for years, it's no news to you that digital screens can cause your eyes to tire by the end of the day. Monitor arms help eliminate these ailments by allowing you to position your monitor screen at the optimal viewing height, angle, position, and distance.

**2. Find your comfortable working posture:** With a monitor arm, it's easy to adjust the screen to eye level and keep it an arm's length away no matter what task you're busy doing. Raising your monitor to the ideal, ergonomic height is critical for finding your most comfortable working posture.

**3. A solution to match your environment:** The critical spec to look for here in order to experience that ease of adjust-ability is a gas or spring lift system that allows for one-touch height adjustments. Besides, if you use two screens, you can opt to use monitor arms with dual mounts. This allows you to arrange both screens in a stable and comfortable position while keeping track of a lot of information

**4. Increase flexibility:** Things that are adjustable, are more flexible. You can increase your comfort as well as flexibility, and monitor arm is the reason for it.

However, every new technology, born to comfort people, is surely having some cons too. Have a look over it.

**1. The Unwanted Bounce:** One of the things we see complained about often is the unwanted bounce that you get while typing or moving a mouse around on a desk. There are ways to remedy this, but it's a fairly common problem that you often can't completely fix.

**2. Design mismatching:** Depending on how picky you may be, finding the perfect color monitor arm to match your setup can be another issue. The reason for this is the lack of available color options in the monitor arm market. You'll typically be able to find black, silver, white, or other basic colors, but if you're looking for something specific, you may run into some issues.

**3. Perfection in lying the monitors:** When you're using more than one monitor and you make an adjustment to one, trying to get the second monitor to line up perfectly next to it can be a problem.

With every good thing, comes so many benefits but along with that, comes some demerits too, all we have to do is to accept the good things with their bad sides too. But before anything else, to choose a product, it is important to have a demonstration of it. Let us analyze a Monitor Arm.

**All you can customize using monitor arm are as follows:**

- a. Height adjustable
- b. Adjustable display distance
- c. Rotatable visual angle
- d. Tiltable display

Monitor arms are dream versions of the people in the past decades, the 2022 version have a lot to benefit the technology as well as humanity.

# "SMART HOME"

- Jigar Mathukiya, Akshay Yadav  
& Rohan Kushvaha (TE ELEX)

## INTRODUCTION

A smart home allows homeowners to control appliances, thermostats, lights, and other devices remotely using a smartphone or tablet through an internet connection. Smart homes can be set up through wireless or hardwired systems. Smart home technology provides homeowners with convenience and cost savings.



## ADVANTAGES OF SMART HOME

Safe homes are the most important aspect of any house. No matter how many locks you use for your house, the risk of burglars and thieves breaking into your house is always there. But having a smart home will lower your security risks by providing security alerts when something happens wrong. Energy saving is probably the primary concern for every house owner. Hence, you would always want to make sure that there is no amount of energy wastage and your home needs to fulfill the need of energy efficiency.

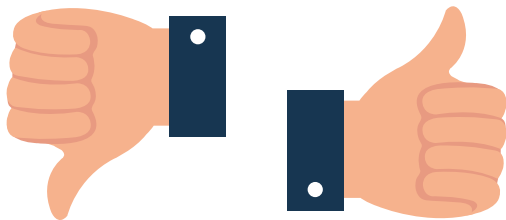

## DISADVANTAGES

The biggest problems, con or disadvantage of a smart home system is the cost. There are quite a number of companies that provide smart home system, but all of them are quite expensive. This is something that only a few can afford. You would be able to have a good savings and income to install this system.

The basic requirement for the smart home system is the internet.

Without a good and strong internet connection, you will not be able to take control of this. If there is no internet connection for some reason, there is no other way through which you can access and control your system.

## CONCLUSION:

With the smart home systems installed in your home, the lifestyle quality will be enhanced. You can control the electrical equipment from your phone easily without having to physically move towards them appliance or the electric switches. Also, your house will be more protected, and hence, you won't have to worry about any intrusion or forceful entry.



# VIRAL MARKETING: SCIENCE OF ARRESTING THE HUMAN INTELLIGENCE

- Gaurav Sharma (SE EC&S)

Viral marketing is a sales technique that spreads organic information and word of mouth about products and services faster than ever before. The advent of the internet and with it social media has greatly increased the amount of viral messages such as memes, shares, likes and forwards. Viral marketing can extend a company's reach and ultimately expand its customer base. Marketing today may be a science. There, knowledge of consumer behaviour becomes increasingly important to reach people, increasing the power to shape brands that stand out with their messaging. Rumours spread through newspapers, radio and television. The latest sales channel, the Internet, is also evolving into a new channel of its own. These internet channels have new names and terms such as Facebook, Twitter, Blogs and YouTube. These are all different names for social communities or networks where people come together and share information. Viral marketing has many problems. Creating the ideal ad that reaches and benefits people is very difficult. The main challenge is to ensure that your ads are not only fun and interesting, but also spread real brand awareness. Just in case your ad gets a negative response, convert it to a positive response. There is also bad viral marketing. Anyone who has ever talked about a restaurant with terrible food knows this phenomenon.

## PROS-

- Wider reach
- Faster and exponential growth
- Lower costs

## CONS--

- Negative word-of-mouth
- Hard to measure
- Low virality

## MONEY AND ADVERTISEMENT-

Advertising it is also known as the science of arresting human intelligence. Because the arrest of human intelligence is

long enough to demand money. Advertising can be described as the science of beating human ingenuity for a period of time and making money off of it. It is used in different ways for all different principles. Ads are a great source of revenue, so the more people who view, share, or like your ads, the more you earn.

The purpose of this white paper is to determine the extent to which viral marketing influences consumer purchasing decisions, brand awareness, and brand associations. To find answers to our questions, we started researching popular literature and articles. From this, we learned what consumer purchasing decisions were or were not, or the effectiveness of advertising. I tried to find out if they would accept it. Understanding the direction in which research should be conducted gives us an important idea of our research philosophy tend to theorize in conclusions.

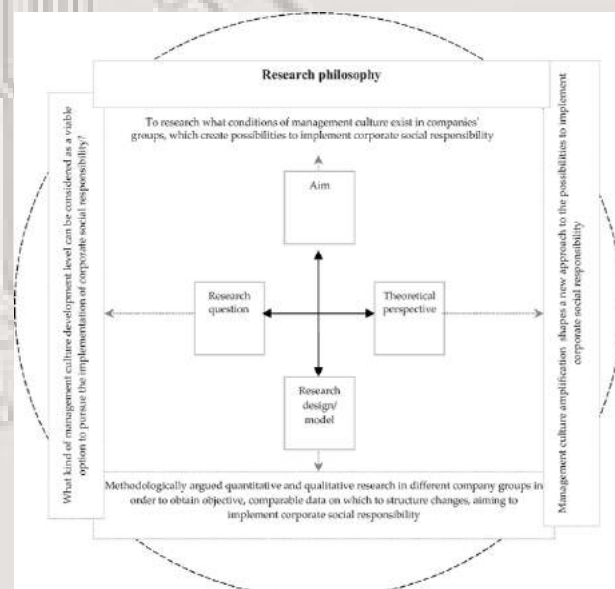

Figure 1 describes the research methodology philosophy, including goals, research questions, theoretical perspectives, and research design. His two different approaches to research are deductive and inductive research. Deductive research is called a research project and represents a standard



view of the relationship between research and theory. Researchers use what is already known from previous research and theory to formulate hypotheses that require empirical testing.

In order to be ready to do that research, I used differing types of graphs on different basis to analyse our data.

Within the graph 1 we will get a thought on the frequency and percentage of various sorts of marketing i.e. telephone marketing, mass media marketing, online marketing, word-of-mouth online, social media network.

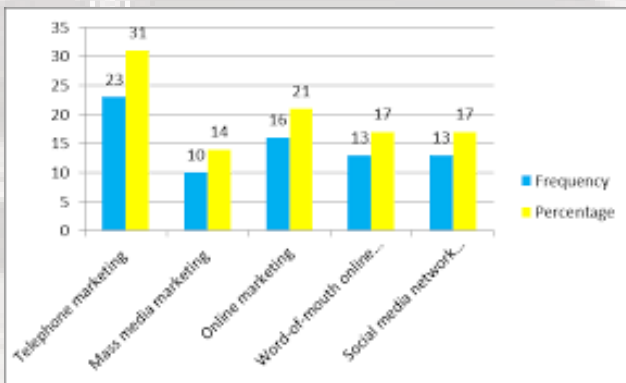

Graph 2 (viralness of content on the idea of emotions)

In graph 2 we will get rough concept during which emotion the content or ads spread faster and wide. The percentage are as below- Awe-25%, Laughter-17%, Advertisement-15%, Joy-14%, Anger-6%, Empathy-6%, others (Sadness, Surprise etc.)-17%

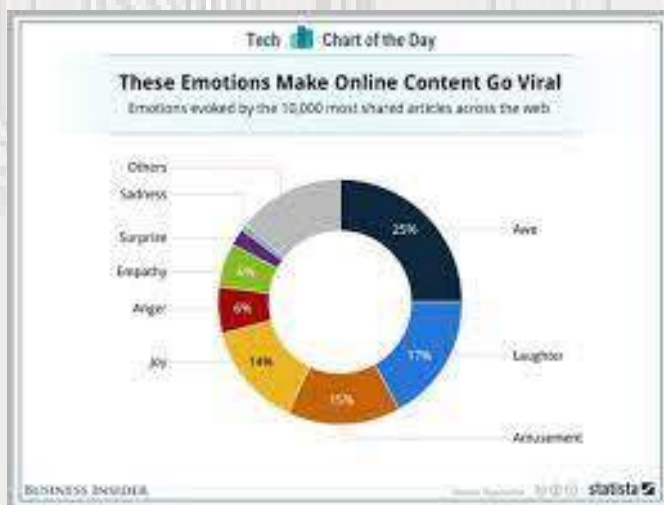

Graph 3 (breakdown of virality supported what we are sharing)

In this graph we'll get a thought of that during which mode it spreads more therefore the values are as below- photos-70%, links-14%, status-10%, videos-6%.

Primary viral marketing communications emerged from the rise of primary markets where merchants sought offers. If a product is worth its price, it quickly spreads awareness and viral marketing (Ferguson, 2008). Organizations create brands to differentiate themselves from their competitors and to stand out from loud and viral marketing messages. The biggest reason for brands is to make consumers aware of your product and your business.

As such, brand awareness and viral marketing are his two key ingredients in the science of sales. Viral marketing is he one of the promotional mix strategies that companies can use to increase brand exposure, increase product awareness and win prices. The purpose of this study was to examine the impact of viral marketing on consumer relevance to a brand.

Additionally, if an ad garners positive or negative attention, it can influence consumer behavior towards the brand. This was explored using relevant theories and models on the topic and tested in an online-based network.

To answer survey question A: How does advertising influence consumers to initiate viral marketing campaigns on the network? These discussions help spread your name and indirectly generate a viral marketing campaign. Response to survey question B: Why do consumers who respond negatively to commercials buy brands? The results show that respondents are more likely to associate commercials with specific parts of commercials than with the brand itself. For this reason, consumers, after seeing a product of a brand they want to see, remember the name but not the advertisement, and choose that brand over other brands to purchase..

# WEB-3.0

- Harsh Dubey & Samarth Bundle (SE IOT)

Web3 (also known as Web 3.0) can be defined as the third generation of online services where AI-based semantics, AR/VR-based immersive-ness, and blockchain-based decentralization come together to create transparent, ubiquitous, open, and socially responsible internet experiences.

## 1. History of Internet.

The history of the Internet has its origin in information technology and the efforts to build and interconnect computer networks that arose from research and development in the US and involved international collaboration, particularly with researchers in the UK and France.

Fundamental theoretical work on information theory was developed by Harry Nyquist and Ralph Hartley in the 1920s. Information theory, as enunciated by Claude Shannon in the 1940s, provided a firm theoretical underpinning to understand the tradeoffs between signal to noise ratio, bandwidth and error-free transmission in the presence of noise in telecommunication technology. This was one of the three key developments, along with advances in transistor technology (specifically MOS Transistors) and laser technology, that made possible the rapid growth of telecommunication bandwidth over the next half-century.

Computer science was an emerging discipline in the late 1950s that began to consider time-sharing between computer users, and later, the possibility of achieving this over wide area networks. Independently, Paul Baran proposed a distributed network based on data in message blocks in the early 1960s and Donald Davies conceived of packet switching in 1965 at the National Physical Laboratory (NPL) and proposed a national commercial data network in the UK. The Advanced Research Projects Agency (ARPA) of the U.S. Department of Defense awarded contracts in 1969 for the

development of the ARPANET project, directed by Robert Taylor and managed by Lawrence Roberts.

ARPANET adopted the packet switching technology proposed by Davies and Baran, underpinned by mathematical work in the early 1970s by Leonard Kleinrock at UCLA. The network was built by Bolt, Beranek, and Newman.

Several early packet-switched networks emerged in the 1970s which researched and provided data networking. ARPA projects and international working groups led to the development of protocols for internetworking, in which multiple separate networks could be joined into a network of networks, which produced various standards. Bob Kahn, at ARPA, and Vint Cerf, at Stanford University, published research in 1974 that evolved into the Transmission Control Protocol (TCP) and Internet Protocol (IP), the two protocols of the Internet protocol suite. The design included concepts from the French CYCLADES project directed by Louis Pouzin.

January 1, 1983 is considered the official birthday of the internet. In the early 1980s, the National Science Foundation (NSF) funded national supercomputing centers at several universities in the United States, and provided interconnectivity in 1986 with the NSFNET project, thus creating network access to these supercomputer sites for research and academic organizations in the United States. International connections to NSFNET, the emergence of architecture such as the Domain Name System, and the adoption of TCP/IP internationally on existing networks marked the beginnings of the Internet. Commercial Internet service providers (ISPs) emerged in 1989 in the United States and Australia. The ARPANET was decommissioned in 1990. Limited private connections to parts of the Internet by officially commercial entities emerged in



several American cities by late 1989 and 1990. The optical backbone of the NSFNET was decommissioned in 1995, removing the last restrictions on the use of the Internet to carry commercial traffic, as traffic transitioned to optical networks managed by Sprint, MCI and AT&T

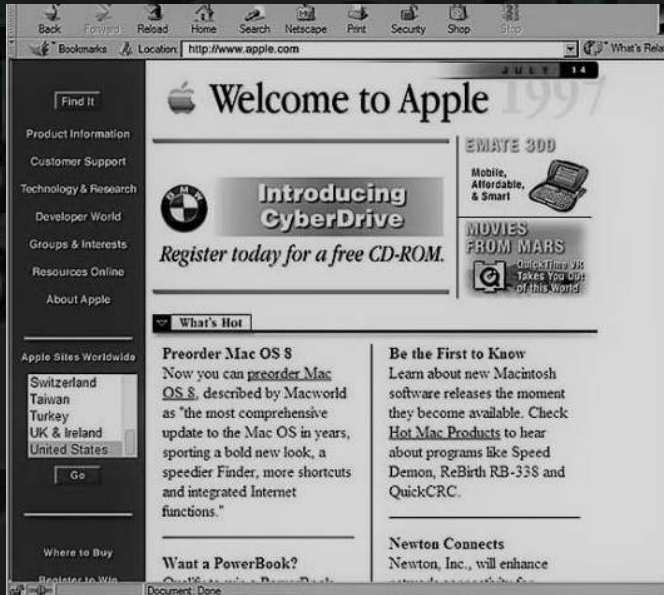

Research at CERN in Switzerland by British computer scientist Tim Berners-Lee in 1989–90 resulted in the World Wide Web, linking hypertext documents into an information system, accessible from any node on the network. The dramatic expansion of capacity of the Internet with the advent of wave division multiplexing (WDM) and the roll out of fiber optic cables in the mid-1990s had a revolutionary impact on culture, commerce, and technology. This made possible the rise of near-instant communication by electronic mail, instant messaging, voice over Internet Protocol (VoIP) telephone calls, video chat, and the World Wide Web with its discussion forums, blogs, social networking services, and online shopping sites. Increasing amounts of data are transmitted at higher and higher speeds over fiber-optic networks operating at 1 Gbit/s, 10 Gbit/s, and 800 Gbits/s by 2019.

The Internet's takeover of the global communication landscape was rapid in historical terms: it only communicated 1% of the information flowing through two-way telecommunications networks in the year 1993, 51% by 2000, and more than 97% of the telecommunicated information by 2007. The

Internet continues to grow, driven by ever greater amounts of online information, commerce, entertainment, and social

- World Wide Web or Web 1.0

The World Wide Web (WWW), commonly known as the Web, is an information system where documents and other web resources are identified by Uniform Resource Locators users by a software application called a web

(URLs, such as <https://example.com/>), which may be interlinked by hyperlinks, and are accessible over the Internet. The resources of the Web are transferred via the Hypertext Transfer Protocol (HTTP), may be accessed by browser, and are published by a software application called a web server. The World Wide Web is built on top of the Internet, which pre-dated the Web by over two decades. English scientist Tim Berners-Lee co-invented the World Wide Web in 1989 along with Robert Cailliau. He wrote the first web browser in 1990 while employed at CERN near Geneva, Switzerland. The browser was released outside CERN to other research institutions starting in January 1991, and then to the general public in August 1991. The Web began to enter everyday use in 1993–1994, when websites for general use started to become available. The World Wide Web has been central to the development of the Information Age and is the primary tool billions of people use to interact on the Internet.

Web resources may be any type of downloaded media, but web pages are hypertext documents formatted in Hypertext Markup Language (HTML). Special HTML syntax displays embedded hyperlinks with URLs, which permits users to navigate to other web resources. In addition to text, web pages may contain references to images, video, audio, and software components, which are either displayed or internally executed in the user's web browser to render pages or streams of multimedia content.

Multiple web resources with a common theme and usually a common domain name make up a website. Websites are stored in computers that are running a web server, which is a program that responds to requests made over the Internet from web browsers running on a user's computer. Website content can be provided by a publisher or interactively from user-generated content. Websites are provided for a myriad of informative, entertainment, commercial, and governmental reasons.

The World Wide Web (WWW), commonly known as the Web, is an information system where documents and other web resources are identified by Uniform Resource Locators (URLs, such as <https://example.com/>), which may be interlinked by hyperlinks, and are accessible over the Internet. The resources of the Web are transferred via the Hypertext Transfer Protocol (HTTP), may be accessed by users by a software application called a web browser, and are published by a software application called a web server. The World Wide Web is built on top of the Internet, which pre-dated the Web by over two decades. English scientist Tim Berners-Lee co-invented the World Wide Web in 1989 along with Robert Cailliau. He wrote the first web browser in 1990 while employed at CERN near Geneva, Switzerland. The browser was released outside CERN to other research institutions starting in January 1991, and then to the general public in August 1991. The Web began to enter everyday use in 1993–1994, when websites for general use started to become available. The World Wide Web has been central to the development of the Information Age and is the primary tool billions of people use to interact on the Internet.

Web resources may be any type of downloaded media, but web pages are hypertext documents formatted in Hypertext Markup Language (HTML). Special HTML syntax displays embedded hyperlinks with URLs, which permits users to navigate to other web resources. In addition to text, web pages

may contain references to images, video, audio, and software components, which are either displayed or internally executed in the user's web browser to render pages or streams of multimedia content. networking services. However, the future of the global network may be shaped by regional differences.

Multiple web resources with a common theme and usually a common domain name make up a website. Websites are stored in computers that are running a web server, which is a program that responds to requests made over the Internet from web browsers running on a user's computer. Website content can be provided by a publisher or interactively from user-generated content. Websites are provided for a myriad of informative, entertainment, commercial, and governmental reasons. The terms Internet and World Wide Web are often used without much distinction. However, the two terms do not mean the same thing. The Internet is a global system of computer networks interconnected through telecommunications and optical networking. In contrast, the World Wide Web is a global collection of documents and other resources, linked by hyperlinks and URIs. Web resources are accessed using HTTP or HTTPS, which are application-level Internet protocols that use the Internet's transport protocols.

Viewing a web page on the World Wide Web normally begins either by typing the URL of the page into a web browser or by following a hyperlink to that page or resource. The web browser then initiates a series of background communication messages to fetch and display the requested page. In the 1990s, using a browser to view web pages—and to move from one web page to another through hyperlinks—came to be known as 'browsing,' 'web surfing' (after channel surfing), or 'navigating the Web'. Early studies of this new behavior investigated user patterns in using web browsers.

One study, for example, found five user patterns: exploratory surfing, window surfing, evolved surfing, bounded navigation and



targeted navigation. The following example demonstrates the functioning of a web browser when accessing a page at the URL `http://example.org/home.html`. The browser resolves the server name of the URL (`example.org`) into an Internet Protocol address using the globally distributed Domain Name System (DNS). This lookup returns an IP address such as `203.0.113.4` or `2001:db8:2e::7334`. The browser then requests the resource by sending an HTTP request across the Internet to the computer at that address. It requests service from a specific TCP port number that is well known for the HTTP service so that the receiving host can distinguish an HTTP request from other network protocols it may be servicing. HTTP normally uses port number 80 and for HTTPS it normally uses port number 443. The content of the HTTP request can be as simple as two lines of text:

```
GET /home.html HTTP/1.1 Host: example.org
```

The computer receiving the HTTP request delivers it to web server software listening for requests on port 80. If the webserver can fulfill the request it sends an HTTP response back to the browser indicating success:

```
HTTP/1.1 200 OK Content-Type: text/html; charset=UTF-8
```

followed by the content of the requested page. Hypertext Markup Language (HTML) for a basic web page might look like this:

```
<html>
<head>
  <title>Example.org - The World Wide Web</title>
</head>
<body>
  <p>The World Wide Web, abbreviated as WWW and commonly known ...</p>
</body></html>
```

## 1. Search engine

A web search engine or Internet search engine is a software system that is designed to carry out web search (Internet search), which means to search the World Wide Web in a systematic way for particular information specified in a web search query. The search results are generally presented in a line of

results, often referred to as search engine results pages (SERPs). The information may be a mix of web pages, images, videos, infographics, articles, research papers, and other types of files. Some search engines also mine data available in databases or open directories. Unlike web directories, which are maintained only by human editors, search engines also maintain real-time information by running an algorithm on a web crawler. Internet content that is not capable of being searched by a web search engine is generally described as the deep web.

- Danger of overload and excess information.
  - Efficient information search strategy is required.
  - The search can be slow.
  - It may be difficult to filter and prioritise the information. Net also becomes overloaded because large number of users.
  - No quality control over the available data etc
- So, World Wide Web is hypermedia using the Hypertext Markup Language or HTML. This unique language will help the user to access information that is to be linked so that when a person selects or clicks on one part of a link their browser automatically finds the designated information. The unique characteristic is that it empowers the users to 'click' on a word and is transported to a related web location.



## 2. HTML

Hypertext Markup Language (HTML) is the standard markup language for creating web pages and web applications. With Cascading Style Sheets (CSS) and JavaScript, it forms a



triad of cornerstone technologies for the World Wide Web.

Web browsers receive HTML documents from a web server or from local storage and render the documents into multimedia web pages. HTML describes the structure of a web page semantically and originally included cues for the appearance of the document.

HTML elements are the building blocks of HTML pages. With HTML constructs, images and other objects such as interactive forms may be embedded into the rendered page. HTML provides a means to create structured documents by denoting structural semantics 1997 for text such as headings, paragraphs, lists, links, quotes and other items. HTML elements are delineated by tags, written using angle brackets.

Tags such as `<img />` and `<input />` directly introduce content into the page. Other tags such as `<p>` surround and provide information about document text and may include other tags as sub-elements. Browsers do not display the HTML tags, but use them to interpret the content of the page

HTML can embed programs written in a scripting language such as JavaScript, which affects the behavior and content of web pages. Inclusion of CSS defines the look and layout of content. The World Wide Web Consortium (W3C), maintainer of both the HTML and the CSS standards, has encouraged the use of CSS over explicit presentational HTML since 1997.

### 3. Web 2.0

When it comes to defining web 2.0. the term means such internet applications which allow sharing and collaboration opportunities to people and help them to express themselves online.

"Web 2.0 is the business revolution in the computer industry caused by the move to the internet as a platform, and any attempt to understand the rules for success on that new platform." – Tim O' Re

It's a simply improved version of the first worldwide web, characterized specifically by the change from static to dynamic or user-

generated content and also the growth of social media.

The concept behind Web 2.0 refers to rich web applications, web-oriented architecture, and social web. It refer to changes in the ways web pages are designed and used by the users, without any change in any technical specifications.

Web 2.0 examples include hosted services (Google Maps), Web applications ( Google Docs, Flickr), Video sharing sites (YouTube), wikis (MediaWiki), blogs (WordPress), social networking (Facebook), folksonomies (Delicious), Microblogging (Twitter), podcasting (Podcast Alley) & content hosting services and many more.

So the major difference between web 1.0 and web 2.0 is that web 2.0 websites enable users to create, share, collaborate and communicate their work with others, without any need of any web design or publishing skills.

What technology benefits more than 3 Billion people for 80% of their waking hours every single day? Web 2.0. Web 2.0, coined as such by O'Reilly and others between 1999 and 2004, moved the world on from static desktop web pages designed for information consumption and served from expensive servers to interactive experiences and user-generated content that brought us Uber, AirBnB, Facebook and Instagram. The rise of Web 2.0 was largely driven by three core layers of innovation: mobile, social and cloud.

With the launch of the iPhone in 2007, mobile internet access drastically broadened both the user-base and the usage of the Web: we moved from dialling up to the internet a few hours a day at home at our desktops to an "always connected" state — the web browser, mobile apps and personal notifications were now in everyone's pocket.

Until Friendster, MySpace and then Facebook in 2004, the Internet was a largely dark and anonymous place. These social networks coaxed users into good behaviour and content generation including recommendations and referrals: from persuading us to share photos

online with specific friend groups; to entrusting unknown travelers with our homes on AirBnB; and even getting into a stranger's car with Uber.

These capabilities were not present in Web 1.0 environment. Now-a-days, the way web users are getting information has drastically changed. Today, users use content they are specifically interested in, often using Web 2.0 tools. The difference shown below between some examples of Web 1.0 and 2.0 justifies why it's time to move to the new version.

Advantages of Web 2.0:

- Available at any time, any place.
- Variety of media.
- Ease of usage.
- Learners can actively be involved in knowledge building.
- Can create dynamic learning communities.
- Everybody is the author and the editor, every edit that has been made can be tracked.
- User-friendly
- Updates in the wiki are immediate and it offers more sources for researchers.
- It provides real-time discussion

Cloud commoditised the production and maintenance of internet pages & applications: new cloud providers aggregated and refined mass-produced personal computer hardware within numerous, vast data centers located around the world. Companies could shift from buying and maintaining their own expensive and dedicated infrastructure upfront to renting storage, compute power and management tools on the go. Millions of entrepreneurial experiments could benefit from low-cost resources that scaled as their businesses grew.

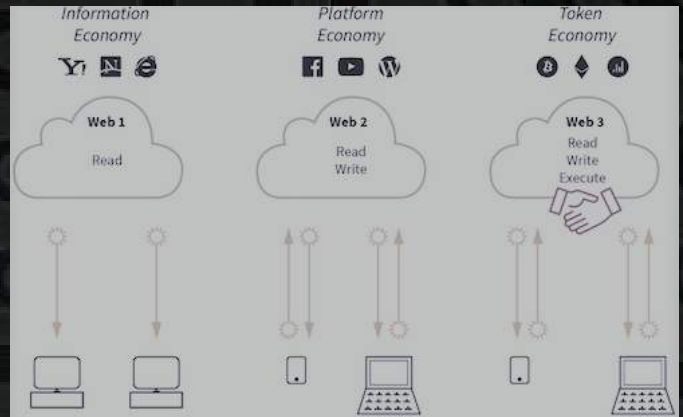

## What Is Web 3.0 & Why It Matters

While the Web 2.0 wave is still bearing fruit, we are also seeing the first shoots of growth emerge from the next large paradigm shift in internet applications, logically entitled Web 3.0. As hard to believe as it might seem, Web 3.0 (originally coined the Semantic Web by Tim Berners-Lee, the Web's original inventor), is an even more fundamental disruption, one that in time will leave everything hitherto in its shade. It is a leap forward to open, trustless and permissionless networks.

- 'Open' in that they are built from open source software built by an open and accessible community of developers and executed in full view of the world.
- 'Trustless' in that the network itself allows participants to interact publicly or privately without a trusted third party.
- 'Permissionless' in that anyone, both users and suppliers, can participate without authorisation from a governing body.

Artificial intelligence & Machine learning algorithms have become powerful enough to create useful, indeed sometimes life-saving, predictions and actions. When layered on top of new decentralised data structures giving access to a wealth of data that would be the envy of today's tech giants, the potential applications go far beyond targeted advertising into areas like precision materials, drug design and climate modelling.

Web 3.0 enables a future where distributed users and machines are able to interact with data, value and other counterparties via a substrate of peer-to-peer networks without the need for third parties. The result: a



composable human-centric & privacy preserving computing fabric for the next wave of the web.

So much for the technology but what difference will this make to the individuals and society as a whole? And how could this be even greater than the impact today's applications have had on our families, businesses and governments? It has been said<sup>2</sup> that the characteristic which sets humankind apart is our ability to organise ourselves in the pursuit of a commonly envisioned goal. Thus it is highly instructive to cast our minds back in time / history, to identify four major social & technological stages in human collaboration:

In Villages, people could trade value, information & work with the small group of counterparties they already knew — their set of counterparties was limited by geographic proximity & personal trust bonds. The small scale meant individuals frequently had multiple roles in society e.g. farmer, fireman, warrior and father. Consequently, transactions were focused on food, security and leisure, and included little coordination beyond largely self-sustaining families.

In Urbanised Cities, the set of counterparties with whom people could trade value, information & work increased significantly. It became economically viable to launch new specialised businesses, produce accounting at the level of that business, and rely on others to produce all the remaining goods and services required by the city's population.

While some geographic restrictions remained, the larger spatial playing field and higher population density led to much wider coordination of skills across individuals.

The ultimate outcome of these new open, trustless and permissionless networks is the possibility to coordinate & incentivise the long tail of work, service, data and content providers that are the disenfranchised backdrop to many of the world's most acute challenges such as health, food, finance and

sustainability. Where Web 2.0 was driven by the advent of mobile, social and cloud, Web 3.0 is built largely on three new layers of technological innovation: edge computing, decentralised data networks and artificial intelligence.

While in Web 2.0 recently commoditised personal computer hardware was repurposed in data centers, the shift to Web 3.0 is spreading the data center out to the edge, and often right into our hands. Large legacy data centres are being supplemented by a multitude of powerful computing resources spread across phones, computers, appliances, sensors and vehicles which are forecast to produce and consume 160 (!) times more data in 2025 as compared to 2010.<sup>1</sup>

Decentralised data networks are making it possible for these data generators (from an individual's personal health data, to a farmer's crop data, or a car's location & performance data) to sell or barter their data without losing ownership control, giving up privacy or reliance on third-party middlemen. As such, decentralised data networks can bring the entire long tail of data generators in to the emerging 'data economy'.

Web 1.0 & Web 2.0 radically shrunk the latency and cost at which people & businesses could trade value, information & work with geographically distributed counterparties they didn't necessarily know, via trusted intermediaries. Truly global businesses started to form, as the reach of counterparties expanded by a few orders of magnitude. At its heart, today's internet allows global coordination via a set of intermediaries, providing a digital social trust layer for strangers to interact: from Facebook, to eBay & AirBnB. Unfortunately we've become overly dependent on these platforms, and when they move from attract to extract, their users (whether individuals or businesses) suffer via higher fees or platform risk (i.e. the platform has the power to destroy your business running on it). While today's interactions might magically and reliably take place on a global scale, it is predominantly the \$200Bn

digital advertising business<sup>3</sup>, with 'we the users' as the product, which fuels this machine. It is now also broadly understood that these platforms of the 'post truth' world have created echo-chambers within which unfiltered and unashamedly populist or indeed fallacious claims reverberate and reinforce — sometimes with chaotic consequences.

With Web 3.0, women, men, machines & businesses will be able to trade value, information & work with global counterparties they don't know or yet explicitly trust, without an intermediary. The most important evolution enabled by Web3.0 is the minimisation of the trust required for coordination on a global scale. This marks a move towards trusting all constituents of a network implicitly rather than needing to trust each individual explicitly and/or seeking to achieve trust extrinsically.

Web 3.0 will fundamentally expand the scale & scope of both human and machine interactions far beyond what we can imagine today. These interactions, ranging from seamless payments to richer information flows, to trusted data transfers, will become possible with a vastly increased range of potential counterparties. Web 3.0 will enable us to interact with any individual or machine in the world, without having to pass through fee-charging middlemen. This shift will enable a whole new wave of previously unimaginable businesses and business models: from global co-operatives to decentralised autonomous organisations and self-sovereign data marketplaces.

This matters because:

- Societies can become more efficient by disintermediating industries, reducing rent-seeking third parties and returning this value directly back to the users and suppliers in a network.
- Organisations can be intrinsically more resilient to change through their new mesh of more adaptable peer-to-peer communication and governance ties between participants.

- Humans, enterprises and machines can share more data with more privacy & security assurances
- We can future-proof entrepreneurial & investment activities by virtually eradicating the platform dependency risks we observe today
- We can own our own data & digital footprints by using provable digital scarcity of data & tokenised digital assets
- Through 'modern mutual' ownership and governance of these new decentralised systems of intelligence and sophisticated & dynamic economic incentives, network participants can collaborate to solve previously intractable or 'thinly spread' problems

The forthcoming wave of Web 3.0 goes far beyond the initial use case of cryptocurrencies. Through the richness of interactions now possible and the global scope of counterparties available, Web 3.0 will cryptographically connect data from individuals, corporations and machines, with efficient machine learning algorithms, leading to the rise of fundamentally new markets and associated business models. The result is akin to a "return to the global village" — daily immersion in the human-centric & highly personalised interactions from which we used to benefit, yet now delivered at the global scale of the internet and supporting an ever-increasing myriad of human and machine skills specialisations.



# RESEARCH

# PAPER





# SCIENCE OF SUPERNOVA

MANASRAJ SINGH

AVANI GALA

DHRUV JAISWAL

SAKSHI DUBEY

RAJNI BAHUGUNA

Supernovae are incredibly dangerous heavenly blasts that may briefly surpass a whole cosmic system, emitting as much energy in a short period of time as a normal star like the Sun would throughout its 10 billion-year lifetime. Supernovae are fast-moving occurrences that last from hours to months. They can be set off by either the abrupt re-ignition of nuclear fusion in a very compact star or the gravitational collapse of a big star's core. A Kind of supernova known as SN 1a, for example, was essential in proving the existence of a mysterious component known as dark energy. Rubin Observatory expects to find three to four million additional supernovae throughout the course of its ten-year study, which will cover a wide spectrum of distances. This gigantic assortment of heavenly blasts will permit us to gain huge headway in cosmic explosion research, permitting us to apply novel methods and experiences to fields as different as the investigation of huge scope structure in the Universe, cosmic explosion blast physical science, and star arrangement and development With supernovae, we can probe the scales of the Universe from even smaller than a single astronomical unit (Earth-Sun distance) to the entire Universe. From studying nearby giants which will someday undergo such a killing, to

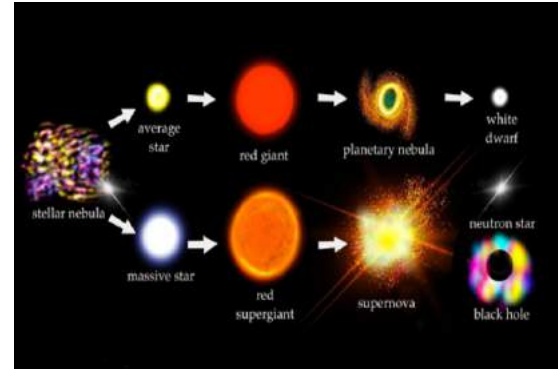

## II. DISCOVERY

Our insight about verifiable supernovae depends totally on old records left by human civic establishments. These records are not dependably exact, and to make an interpretation of the text into observational information has been quite possibly the most difficult issue confronting cosmologists. Present day satellites and Earth-based observatories are the principal apparatus to recognize supernovae leftovers left by the blast. In any case, the divine facilitates and age of these leftovers need to match precisely the accessible antiquated records. The Vela Supernova Remnant was generated by a supernova explosion that occurred 10,000–20,000 years ago.

Unknown Indian observers may have seen and documented the earliest conceivable recorded supernova, known as HB9. It had the appearance of a star and did not travel across the sky like a comet. These discoveries are viable with the presence of a cosmic explosion, and This is believed to be mankind's most seasoned affirmed record of a cosmic explosion event. Unsubstantiated supernovae events may have been seen too.

## III. EARLY OBSERVATION

SN 185: The earliest account of a supernova comes from 185 CE, when a "Guest Star" was seen in the night sky for roughly eight months. The remnant RCW 86 was discovered as the source of the explosion. The Chandra X-Ray Observatory of NASA and the XMM-Newton Observatory of the European Space Agency were combined to get a crisp picture of RCW 86

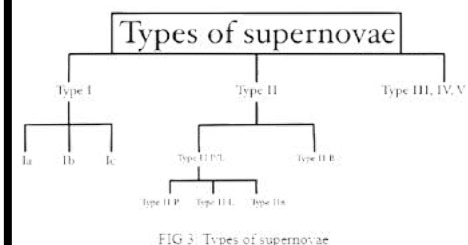
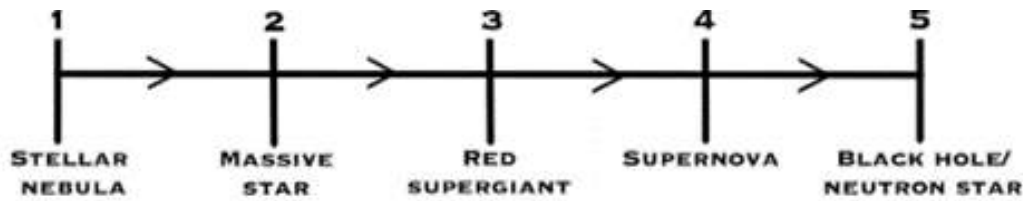

FIG 3 Types of supernovae



## V [A].TYPE I

Type I supernovae can be partitioned into three subgroups-Ia, Ib, and Ic in view of their spectra. The specific idea of the blast instrument in Type I for the most part is as yet dubious, in spite of the fact that Ia supernovae, in any event, are remembered to start in twofold frameworks comprising of a decently huge star and a white midget, with material streaming to the white smaller person from its bigger sidekick.

## TYPE II L

Perceived as a particular kind of cosmic explosion in the mid 1940s, Type II (SNII) are described by hydrogen outflow in their spectra, and light bend shapes that contrast essentially from those of Type I supernovae. SNII are sub-ordered relying upon whether their light bends show a direct decrease after greatest (SNII-L) or a level stage (SNII-P) where the splendor stays consistent for a lengthy time frame.

## VIII. EFFECTS ON EARTH

Every 240 million years, a supernova explosion happens within 10 parsecs (33 light-years) of the Earth. The majority of the negative impacts that a supernova can have on an inhabited terrestrial planet are caused by gamma rays. In the case of the Earth, gamma rays cause radiolysis of diatomic N<sub>2</sub> and O<sub>2</sub> in the upper atmosphere, transforming molecular nitrogen and oxygen to nitrogen oxides and exposing the surface to hazardous solar and cosmic radiation. Phytoplankton and reef populations would be particularly harmed, potentially depleting the marine food chain's foundation.

## X.SOURCE OF HEAVY ELEMENTS

Supernovae are a significant supply of components within the interstellar space from Oxygen (O) through to Rubidium (Rb). [18] Core collapse supernovae eject a lot of smaller quantities of the iron-peak elements than type IA supernovae. The majority of the fabric ejected by type II supernovae is chemical element and helium.

## XIII. CONCLUSION

It is to be concluded by our paper currently, that Supernovae are very unstable heavenly blasts. The insights about the chronicled supernovae depend completely on antiquated records left by human developments. The earliest record of a cosmic explosion comes from 185 CE when the "Guest Star" was found in the night sky

The Supernovae are divided into three sections with type one and type two having three and two subtypes. Supernovae are most likely strong cosmic wellsprings of fascination waves, however, very few, to this point have been recognized. The sole gravitational wave that occasions up, until this point, are distinguished from consolidations of dark openings and nucleon stars, likely remainders of supernovae.

# IOT FIRE DETECTION AND RETARDATION FOR PASSENGER TRAINS

MAYUR CHAVAN

SHANTANU KUDAV

MS. JALPABEN PANDYA

DR. G. SUDHA,

In the process of making Indian passenger journey safe, Indian Railways improved on their fire safety measures like fire retardant material, extinguishers. etc. To make it safer a wireless fire & alert system is the perfect solution. "The saying that every person runs a risk the moment he steps out of the residence brings out the importance of safety in transport." So, we have proposed the IoT-based Fire detection, fighting & retardation alarm system. As IoT is booming & being deployed to enhance functionalities for many businesses. Integrating it into our system will make the connected world safer. There are many techs are used to build the connected environment among wide devices to enable a smart ecosystem. Normally these technologies include RFID, Bluetooth, WLAN, NFC, LR-WPAN, and 6LowPAN. As different applications require different specifications, these communication technologies are used.

## LITERATURE REVIEW

**LoRaWAN:**  
The main purpose for using LoRaWAN is to cover large geographical areas using radio signals. This helps in easy wireless transmission. Long Range (LoRa) is the technology that transmits small packets of data to a receiver over a long distance.

## B. IoT:

IoT, i.e., the Internet of Things is the process of connecting sensors and actuators with the microcontroller that connects the two with the help of Internet connectivity. IoT is a step-up upgrade of embedded systems. IoT has had advancements in the field of industries, automobile, airline industry, medical, simulation, etc. The Internet of Things can intake information, analyze data, make decisions and record output. In other words, it can be said that the Internet of Things is smarter than the Internet. IoT has played a major role in bringing about technological advancements in the field of automation of robotics.

## C. Firefighting and retardation system:

The traditional firefighting system was a long process and riskier. Since the train would always be in motion, it is a panicky situation as the passengers are on the train the whole time. Usually, when the train catches fire, the passengers are supposed to use the emergency helpline to inform the authorities, who would then inform the fire stations and update them on the condition and location of the train. The firefighters would then arrive at the location and rescue the trapped passengers by putting out the fire. Simultaneously, the retardation system during the entire process would be completed in the hands of the driving official present on the train.

## Proposed Architecture

### Layer I (Nodes):

Here, the condition of AC, as well as non-AC compartments, are covered. Every compartment would contain a button enclosed in a glass panel, associated with a small hammer alongside the glass panel. In times of emergency fire, the passenger can break the glass and press the button. On pressing the button, the signal would be sent through LoRaWAN to the Main Engine Room, which would contain the gateway/concentrator.

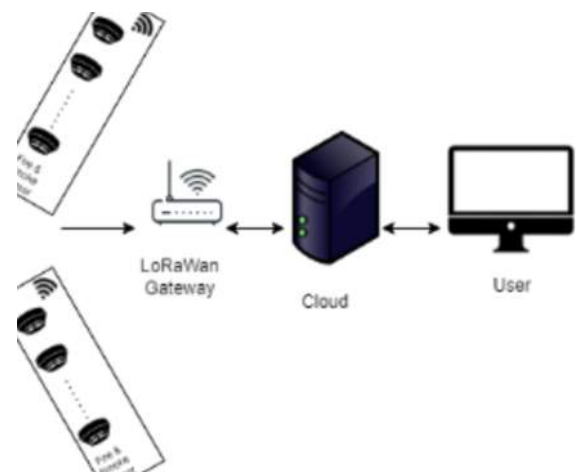

### Layer II (Gateway):

Layer II is the intermediate part of the entire process. It connects the compartments with the fire stations. The button pressed in any of the compartments (Passenger, Pantry room) would set off an alert in the LoRaWAN gateway present in the engine room. The driving official present in the engine room would be warned of a potential fire in a particular compartment of the train so that he can take the required steps to warn other the train station of the same.

### Layer III (Fire Station):

The fire stations would have an app interface that would be designed specifically for alerting the firefighters of potential fire emergencies in the trains. The app would show the alert message and the live location of the train. The alert message sent by the LoRaWAN gateway would be sent to the cloud using a data network or Wi-Fi. The message on the cloud would be displayed to the State Fire Station, along with the live location of the train. The fire station centre would then appoint their firefighters from local fire stations based on the location of the train.

## Result and Discussion

The Smoke, Gas, Fire & SoS Buttons Sensors are placed at the appropriate locations in Coaches. As the IoT is becoming predominant more and more, the devices capable of communicating remotely from distance without using a lot of energy have become a requisite more than ever. This challenge of the future is currently served by Long-Power Wide-Area Networks (LPWAN). Currently, there are a lot of applications based on the LPWAN technology, but most of them do not have the LoRa module incorporated.

## Conclusion

Railway Emergency Support is an important topic. Around this topic, we presented our smart and cost-efficient conceptualization of the fire & SoS system. The conducted experiments show high potential for LoRaWAN technology as an IoT architecture for smart rail fire & SoS applications. It requires some further prototype investigation to prove & improve it. Finally, we also started some important up-gradation to the system. It would substantially decrease the response time to minimize the potential casualties at a low cost.

---

## SHREE – A SMART WATCH

---

Satyam Singh Rajput

Harsh Shigwan

Vinit Singh

---

Women safety in India is a big concern which has been a most important topic , women are neither safe in houses not outside ,women travelers from other countries are also in dubious state while thinking of coming to India. However this fear cannot keep them away from any kind of social activity , because many actions are taken regarding women safety by implanting different laws , rules and inventing new techs for them like SMARISA is a portable device for women safety, it comprises of hardware components such as Raspberry Pi Zero, Raspberry Pi camera, buzzer and button to activate the services.it is activated by the victim by clicking the button .Upon clicking, the current location ,camera captures picture of the attackers which are then send to the police and family members of the victim by the smart phone of victim.

Many similar devices are created for women's but still it will only act when they will get the time to activate it but in our technology they will use it has a shield it will activate just by a command it will be a device in your smart watch that will eject two tentacles from the lower portion of the watch which will give current to the skin portion it is touched by its owner to the person the amount of current which will be given by the watch is dc 40ma it will cause pain with loss of voluntary muscle control it will not fully burn the area but give a small burns  
And it will be activated when a person says activate Shree the tentacles will come without giving any damage to the owner and will also send an sos

---

### METHODOLOGY :

The device can be activated by just merely giving a voice command by the user .this device gets activated and sends instant location with a distress message to the emergency numbers given by the user, through a GSM module.

Voice command : It is the most important feature of the watch.it will be only activated by the voice provided by the user , As soon as the user gives the command to activate the tentacles of the watch and it will activate the shocking system of the device, for giving the shock the tip of the tentacles will contain a square type portion which will be flexible once it touches the skin surface of the threatner .

---



Shock system :

The device also includes coil boosters that act as a current enhancer and it will increase the current given by the battery and send to the tentacles on the commands which will act as a weaponry and helps women to defend themselves

Lithium battery : A lithium battery is type of rechargeable battery in which lithium ions move from the negative electron through an electrolyte to the positive electrode during discharge and back when charging

Bluetooth locket : For the convenience of women, we have transformed the Bluetooth commanding device into a locket which will be there in your neck and work has a mic for commanding

Components : transformer , lithium battery, Bluetooth locket ,circuit.

Transformer : A transformer is a device which increases or decreases the voltage according to the configuration given to it

Hardware :

The device will be made of plastic and fully insulated and water proof so there will be no chance of short circuiting if water is spilled on it , the tentacles (in fig1.6&1.5) the tip of it is used for giving current and the rest part will be covered with rubber to avoid getting the shock back to the user

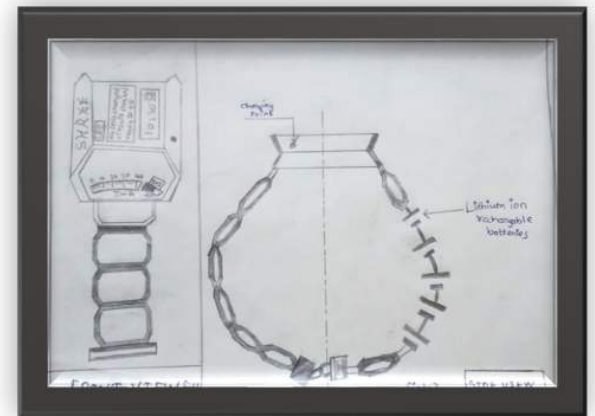

Battery : The battery of the watch depends on the consumption by the user minimum it will last for 4 days with full usage even if the batteries situated in the wrist get drained there will be a battery backup that is emergency power, it should be only used in the worst conditions because once the emergency power section is activated on command the watch will produce maximum current at the

EARPIECE : The working of the earpiece is same as the necklace it just depends on the user what she would like to wear to control the watch .

Any of these the watch or necklace can be used to activate the watch .

“THE DESIGN OF THE WATCH,EARPIECE ,NECKLACE IS MADE IN SUCH A MANNER TO MATCH UP WITH THE CURRENT FASHION ERA “

NECKLACE: It will be made of recycleable plastic consisting the mic commanding circuit inside it will be available in different size ,designs, for different users according to their wish and the battery of it will last for 48hours once charged and to activate you have to set your own code in the starting and you can change it whenever you want it will come default has “shree” ,and for activating the current giving tentacles there will be a different command and same for the SOS message sending the whole data of your voice commands will be stored in the memory of the device safe and secured ,” THE DEVICE WILL BE ONLY ACTIVATED WITH A SINGLE USER VOICE AS THE VOICE COMMAND UNIT IS MADE FOR A SINGLE USER INTERFACE “

**RESULT & OUTCOME:** The main function of our device is to help women in dangerous situations so when she feels unsafe she activates the watch using voice command and the watch will activate its tentacles for giving shock in 5 seconds and then she will be able to give shock by just touching to the perpetrator from the range of 10ma to 40ma according to the situation faced by her, the threatener will face a mild pain and muscle contractions and some burns will be left at the place where the tentacles touch it.

“Our main motive is to make the women working in night shifts or for the college girls to feel safe and secure”

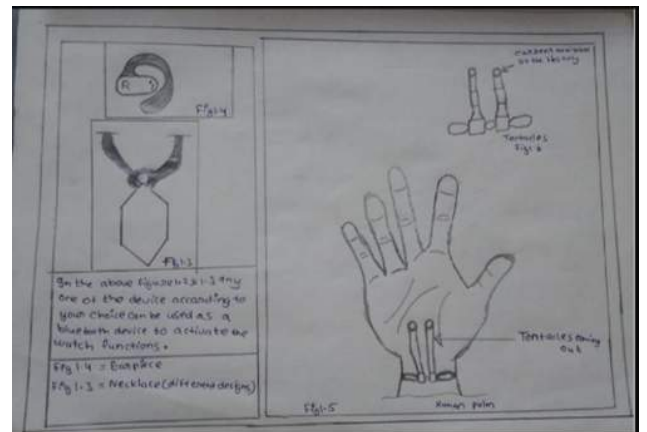

**CONCLUSION :** Our product has purpose to provide security to women in current scenario. In case the woman feels need of self-defense she can make use of watch to temporarily incapacitate a perpetrator. The paper presents the prototype of a smart watch for women's safety performance metrics have to be conserved for further analysis to prove its efficiency.

“ Our primary principle of this project is to ensure every woman in our society to feel safe and secure

---

# Self Propelled Battery Management System in Electric Vehicles

---

Swati Khanna

Janani Menon

Akshata Sharma

---

Sunil Khatri

---

From the beginning of the 21st century the motor vehicles production has increased exponentially. The amount of release of CO<sub>2</sub> is significantly increasing which proves the non-reliability on conventional sources of energy.

This gave revival to the research left by William Morrison to be picked up again in 1990s and quickly accelerated in 2010 since then a lot of new concepts related to the same have come to limelight and made us ponder if the switch to electric power is more or less reliable. The electric vehicle has different types like the Full hybrid EVs or Plug-in EVs which have batteries that are solar powered. But this has certain limitations like high cost, placement of panels, maintenance, more applicable in tropical regions, etc. Hence, the preference is given to normal EVs at the time. Many models have come forward in India like the TATA Tigor which have escalated the requirement of electrical and electronics-based engineers as the work has to be done on battery power management [1].

---

## 2.1 Battery Management System

Any electronic system that manages a rechargeable battery, such as protecting it from operating outside its safe operating area, monitoring its state, calculating secondary data, reporting that data, controlling its environment, authenticating it, and/or balancing it, is referred to as a battery management system.

## 2.2 Battery Pack

Alessandro Volta was the first to give a model of a true battery. Since then, there have been a lot of changes in the shape and design of battery. In case of an Electric Vehicle there are 3 types of batteries which are considered for the system. These are:

Li ion batteries

Lead acid batteries

Nickel metal hybrid batteries

---

## 2.3 State of Charge

The SOC stands for the state of charge of BMS in an EV. The definition of the same is the capacity remaining of the pack w.r.t the total capacity of the pack now. In terms of a formula, it is represented as,  
$$\text{SOC} = \frac{\text{Current Rating or Capacity}}{\text{Total Rating or Capacity}}$$

## 2.4 State of Health

SOH for an EV BMS is the state of health of the system. It is defined as the Total capacity life today w.r.t Capacity at the beginning of life

$$\text{SOH} = \frac{\text{Total Capacity now (Ah)}}{\text{Beginning of Life Capacity (Ah)}}$$

---

## 2.5 State of Energy

In case of a BMS one of the important parameters to be considered is the safety envelope or the SOE which provides us with the maximum limit. The SOE is defined as the maximum charge or discharge value of current permissible for a battery pack at any given time. The value for the same is specific to each cell considering the previous data available. The curve for the charge and discharge values observed is plotted which helps in determining the region in which the operation of the same is safe.

## 3 RESULTS AND DISCUSSION

### 3.1 Li-ion single cell constant current discharge and charge cycle monitoring

The single cell testing is done first to monitor how the current from the cell is discharged over time by observing the variation of voltage, current and state of charge value over time. Li-ion cell is selected owing to its efficiency and price where during discharge almost constant current discharge is seen which switches immediately to zero when the charge cycle begins. This points to the behavior of the battery tending towards ideal conditions.

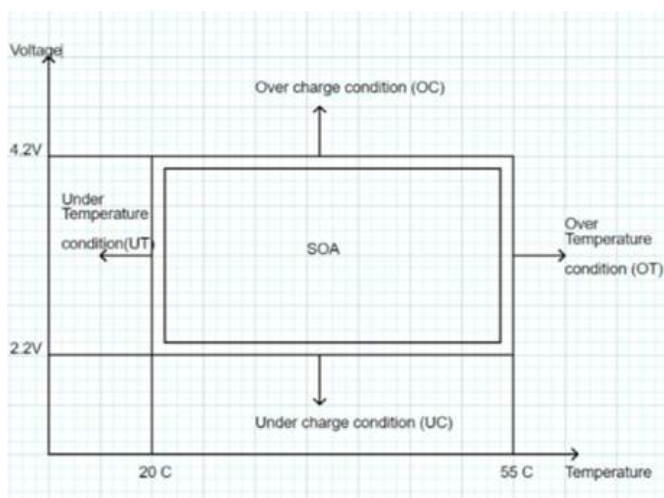

## 2.6 Temperature

The BMS has the necessary sensors to monitor certain factors such as moisture, motion and most importantly Temperature. The maintenance of voltage and temperature of each cell is through individual monitoring and pack monitoring. The limit for the temperature allowance is defined through the graph where a safety envelope is made to prevent the same. If the temperature goes to OT which is the over temperature condition it may lead to a thermal runaway [7]. Similarly, the lesser temperature limit will lead to UT which is under temperature condition that leads to the dendritic growth which are micro fragments that may lead to short circuit and not permitting the charge/discharge cycles. Hence, there is a master disconnect provided for the same which disconnects the circuit in case either of the case.

### 3.2 Battery Pack passive cell balancing charging and discharging cycle

After testing on individual Li-ion cell an entire battery pack consisting of 12 in each set are tested on with using passive cell balancing algorithm which means that the strong cells are made to lose their extra charge and store it elsewhere or use it first to equalize the value. Here the load connected is the RLC branch representing one motor attachment. The monitoring of charge levels of both the set of cells is done where one is the strong set and one the weak set. The final set output is seen on the SOC display which indicates for the passive cell balancing being in effect on changing the RLC branch value which signifies change in environment of working. This acts as a test to see the effective deployment of algorithm on Li-ion battery.

---

### 3.3 Battery Management System Implementation

The testing of the entire Battery Management system is done through simulation where the observation of cell balancing algorithm was done. The observation was when the CAN module connects the load to the system it gives an indication to begin the process and hence the cell balancing takes place and gives constant output after that. Once the CAN module disconnects the system the algorithm is ineffective and the SOC value returns to previous recorded or slightly changed.

---

### 4. CONCLUSION

The research puts forward all the parameters which will be put forward to use when developing the system model. The most crucial factors to be kept in mind is the battery pack design to fit the cells properly according to requirement as well as have less maintenance. The different sensors are going to be used which will be sensing the temperature, motion, moisture and many such factors which may hinder the working of the EV. This present paper focusses on the study of BMS and optimizes the power performances of electric vehicles. Moreover, the target of reducing the greenhouse gases can greatly be achieved by using battery management system in EV.

---



# ROBOTICS





# HISTORY OF ROBOTICS

- Maharshi Thakkar (TE ELEX)

Do you know the meaning of the word "robot"? Etymologically, the term comes from the Czech word *robota*, which means 'forced labour'. It was first used 100 years ago in a play by the author of the same nationality, Karel Čapek.

This game called 'RUR (Rossum's Universal Robots)' premiered in 1921 and was a huge success all over the world without knowing it, a word that will last forever. To talk about the origins of robotics, we have to mention Aristotle and his ideas about 'automated tools', Henry Ford, Leonardo Da Vinci and his mechanical knight or Isaac Asimov. Here we name the milestones that already in the middle of the 20th century brought real progress towards automation and autonomous mobile robotics.

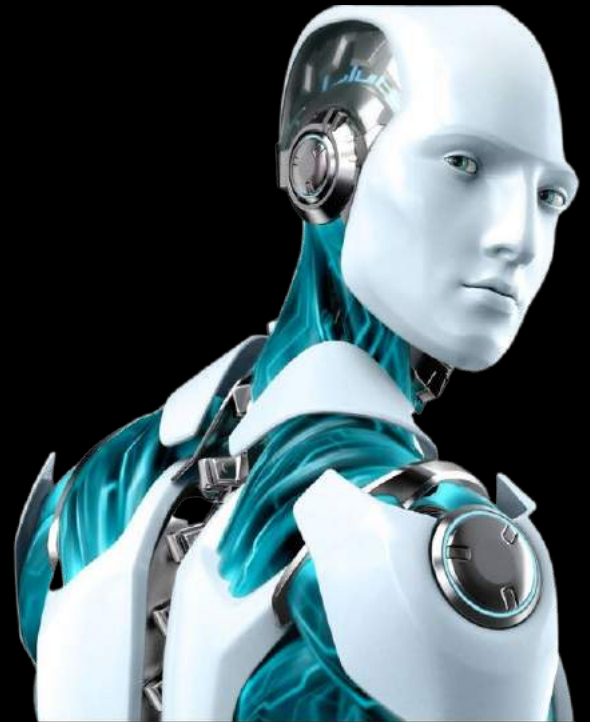

Industrial robots usually do not have a humanoid shape, although they are able to reproduce human movements and behavior, but with the power, precision and speed of a machine. The first industrial robots were developed by George Devol, an American inventor and founder of the first robotics company in history: Unimation.

In 1954, what is considered the first industrial robot was developed in the US: the Unimate hydraulic arm, used for heavy lifting, which was sold to General Motors. In the following years, several versions of the same model were developed by Unimation, which were gradually introduced in some factories, mainly in the automotive sector.

It was in the late 1960s and 1970s that significantly more advanced robotic arms appeared that already used cameras or sensors. Designed in 1966 by the Stanford Research Institute, the Shakey robot stands out as an important milestone for mobile robotics. Shakey was the world's first mobile robot, thanks to software and hardware that allowed it to perceive and understand its environment, albeit in a limited way.

In parallel, the first mobile industrial robots also appeared. In 1954, Barrett Electronics Corporation introduced the first electric vehicle that did not require a human driver, which we know as the first AGV (Autonomous Guided Vehicle). AGVs acquired more complex behavior in the 1980s as technology advanced, and as early as the 1990s we found AGVs with much more accurate sensors and lasers. As explained in another post, an AGV is not an autonomous mobile robot. It is useful to understand the differences between the two in order to make the right decision when implementing them in a factory or company

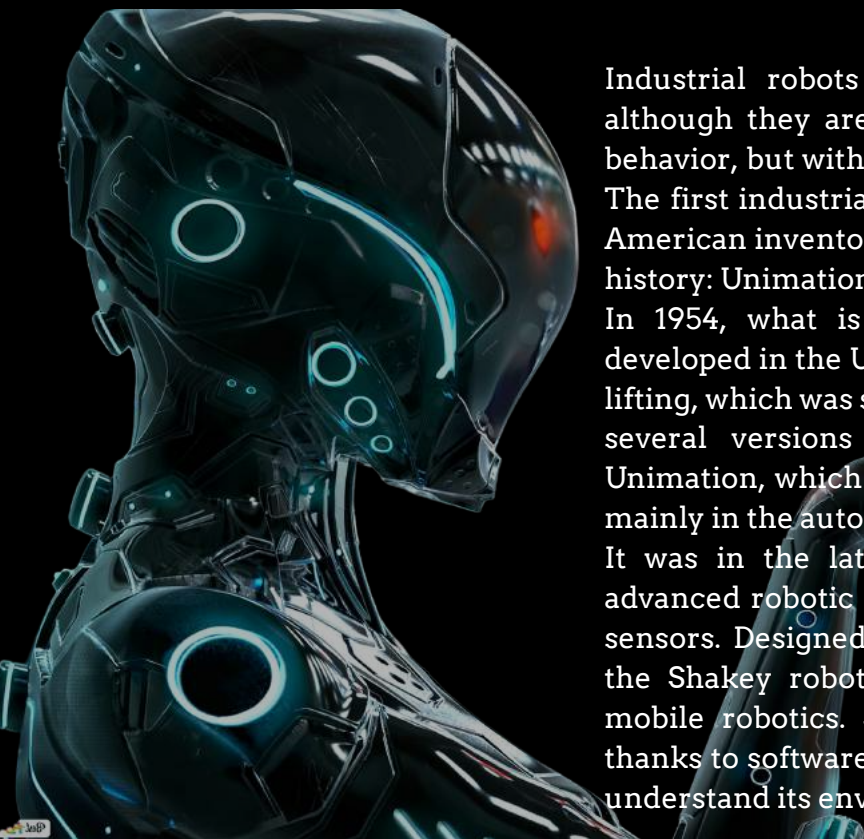

## 1980s and 1990s

Although the first industrial robots originated in the United States, in the 1980s and 1990s they were already being developed in some European and Asian countries, mainly in Japan and Sweden. You probably remember how IBM Deep Blue beat world champion Garry Kasparov in a game of chess.

Nowadays, the development of artificial intelligence or other technologies like those mentioned at the beginning of the article is so strong that playing against Kasparov sounds outdated. The applications that AI brings to robotics, and by extension the industrial sector, are infinitely more valuable and profitable than winning chess games. Some of the benefits that AI brings to industrial robotics are:

Increased accuracy

Better decision-making (especially in the face of obstacles).

Predictive maintenance

Automation is a field that is constantly changing, so sometimes it is difficult for some companies to embark on the path to a smart factory. For this reason, Robotnik always facilitates, accompanies and adapts mobile robotics to the specific needs of the company, regardless of its size. Automation and robotization go hand in hand.

## Service robotics

Collaborative robotics is by definition service robotics. This is the sector in which Robotnik has been developing its activity for 20 years and which has allowed it to become a global reference company.

A service robot for professional use is defined as a robot that works partially or fully autonomously in the service of human welfare and equipment, excluding manufacturing operations (ISO TC 184/SC2 definition).

We found several cases of service robotics that Robotnik is currently involved in. A clear example of this is reflected in the time of the Covid-19 pandemic, where service robotics was crucial in various areas.

Currently, Robotnik develops its robots and mobile manipulators for very diverse industries: logistics, inspection and maintenance, defense, agriculture or security, among others.

## Industrial robotics: present and future

Although industrial robotics has been reserved for large companies for years, Robotnik now offers mobile robotics solutions for small and medium-sized businesses as well. These companies must bet on innovation and technology if they want to remain competitive. In this sense, the cost of investing in mobile robotics is an investment.

Currently, there is already talk of the birth of the fourth industrial revolution, where autonomous mobile robotics plays a major role. Intelligent robots are playing a vital role in the digitization of entire industries worldwide.

Flexibility, machine-human collaboration and diversification into new sectors and business models will set the pace for robotics in 2021, according to findings published by the International Federation of Robotics (IFR). Therefore, we must not lose sight of the keys that will help companies continue to grow in the best possible way.



# NANO ROBOTICS

- Harsh Shigwan (SE E&CS)

Consider a world in which cell-sized robots operate inside our bodies. This may whistle like a science fiction story by Isaac Asimov or an imaginative speech by Richard Feynman, but micro/nanorobotics may soon play a crucial part in medication. All nano- to micron-sized devices (300 nm–300 μm) capable of turning electrical energy into kinetic energy is referred to as medical micro/nanorobots. The main descriptions of powered micro/nanorobots fall into three categories. The motor of the micro/nanorobot in biohybrid systems condenses synthetic nanostructures with motile microorganisms. Nanorobotics is the study of robotics at the nanometer scale, which contains nanoscale robots and huge robots eligible of utilizing items with nanometer determination that have dimensions in the nanoscale range.

A nanometer, or  $10^{-9}$  of a meter, is one billionth of a meter. It originated from the Greek term dwarf. It is defined as the study and creation of substances, systems, and tools that display biological, physical, and chemical properties that are distinct from those observed on a larger scale (matter smaller than the scale of things like molecules and viruses). Nanorobots are microscopic devices that have dimensions measured in nanometers (one nanometer equals one-millionth of one millimeter). Nanorobots can readily navigate the physical human body since they are so small. Nanorobotics is the field of engineering that produces robots or machines on the verge of microscopic nanometer scale.

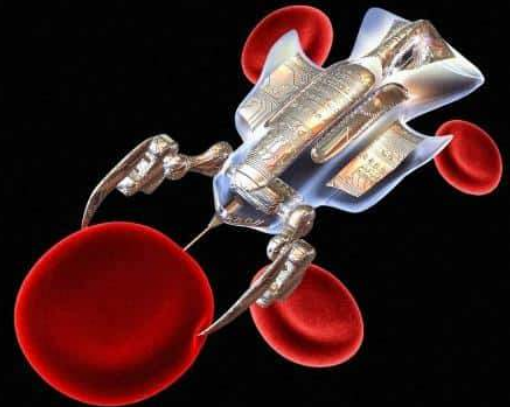

## **Application of Nanorobots in the Medical sector**

The ideal nanorobotic system for more medical and pharmaceutical applications is envisioned as a self-assembling, self-replicating, and self-repairing system. The use of viral vectors or very tiny virus-like particles (VSVLI) as carriers for medications, diagnostic agents, or other therapeutic biological material may make it possible to create such a sophisticated artificial system, even though it may not happen anytime soon.

When compared to passive diffusion techniques, medical micro/nanorobotics have a huge potential to administer medications with a better level of precision and speed. Applications have typically been driven in this direction. Thus, recent in vitro advancements in micro/nanorobotic chemotaxis and material research using stimuli-triggered drug discharge have cared for targeted delivery. For instance, fluorouracil medicine was delivered using magnetically guided nanorobots to inhibit tumor growth in a mouse model. A high concentration of the therapeutic substance was distributed by the nanorobotic platform in a focused region of the tumor once the drug was released, which was externally triggered.



## Nanofabrication

Scientists have currently succeeded in developing biological nanorobotic systems, whereas artificial nanorobots are still a concept that is being aggressively explored. The main challenge in developing these is their fabrication and assembly at the nanoscale. Several techniques for nano-manipulation are being developed, including scanning probe microscopy (SPM) and Atomic Force Microscopy (AFM) as two promising methods for developing nanodevices. These methods make use of microcantilevers, which are ideal for miniaturized manipulation and assembly. Another useful method is the self-assembly of nanostructures.

## Wounds Healing

The human body has a variety of biological triggers and systems for detecting wounds and treating them. However, these biological mechanisms may be ineffective if the wound is actively bleeding or if there are not enough localized coagulant substances in the desired area (Das and Baker, 2016). Medical micro/nanorobotics work in this direction to simulate such systems by utilizing active delivery for quick and efficient wound healing. It has been claimed that chemically-propelled calcium carbonate-based microrobots can deliver thrombin to stop bleeding in the vasculature of mouse and pig models. Lateral propulsion, buoyant rise, and convection together made up the distribution mechanism (Baylis et al., 2015). Another method described involved using railway microrobots to seal wounds with lasers.

## Conclusion

An emerging field that connects several branches of science and technology is nanorobotics. The benefits and uses of robots in MedicineNet engineering technologies are weighed against the difficulties and delays encountered during their development. The examples of biological molecular motors and biological nanorobotics show how challenging but feasible it is to construct such systems. The area of nanomedicine may soon see the introduction of nanorobotics as a benefit for people with AIDS and other difficult-to-treat cancers.

# ELECTRONICS AND ROBOTICS

- Mansi Vaghasiya (TE ELEX)

Robots have helped humans explore space and the deep oceans, and their application is expanding into healthcare, agriculture, food preparation, manufacturing, and true education. Robotics is a multidisciplinary area that combines electrical engineering, mechanical engineering, and computer knowledge. This area includes embedded programming, control systems, automated decision-making, and power electronics. These areas must work together to perceive, allow, and act (the core tracts of a robotic system). Robotics topic chances include computer vision, artificial intelligence, robotic dynamics, and mortal-robot relation.

Employment occasions range from industrial automation, planning control systems for non-robotic systems (like airplanes), and delving into advancements necessary to make robotics a commercially feasible industry (similar to iRobot). There are several companies that presently offer job openings locally, but numerous companies are located throughout the nation. Electronics Engineering is each about devices made up of semiconductors! The introductory difference between electronics and electrical is that electronics deals with veritably low voltage or current whereas electrical deals with high voltages and huge machines.

So a robotic body it should run for the longer term with lower power so the use of electronics is obligatory as using lower power.

Also, electronic bias can be programmed to perform certain tasks, and all credit to digital electronics. They also store certain data within their own memory. So clearly you get Processing, Programming, and storing all in a single chip. Whereas performing this using electrical sense is way too delicate.

Hence robotics generally consists of mechatronics (Mechanical and electronic) structure sense. And hence as these devices are largely filled with programmed electronic factors and these control the mechanical parts used and this is programmed to perform tasks by the robot.

Electronics and semiconductor assiduity has surfaced as an important sector for robotics. While automotive operations still constitute the captain's share of robotics, the volume of robot deals to the electronics and semiconductor assiduity shot up by nearly two-thirds during the first quarter of 2011, according to data collected by the Robotic diligence Association. (RIA, Ann Arbor, Michigan)

"The ease of use of robotics for electronics and semiconductors has increased extensively which has latterly reduced installation times and total cost of enforcing robotic results," says Rush LaSelle, Director of Global Deals and Marketing with Adept Technology Inc. (Pleasanton, California) LaSelle and his peers in the robotics assiduity see more important yet less precious robots proliferating for products of semiconductors and electronics.

# INTERVIEW

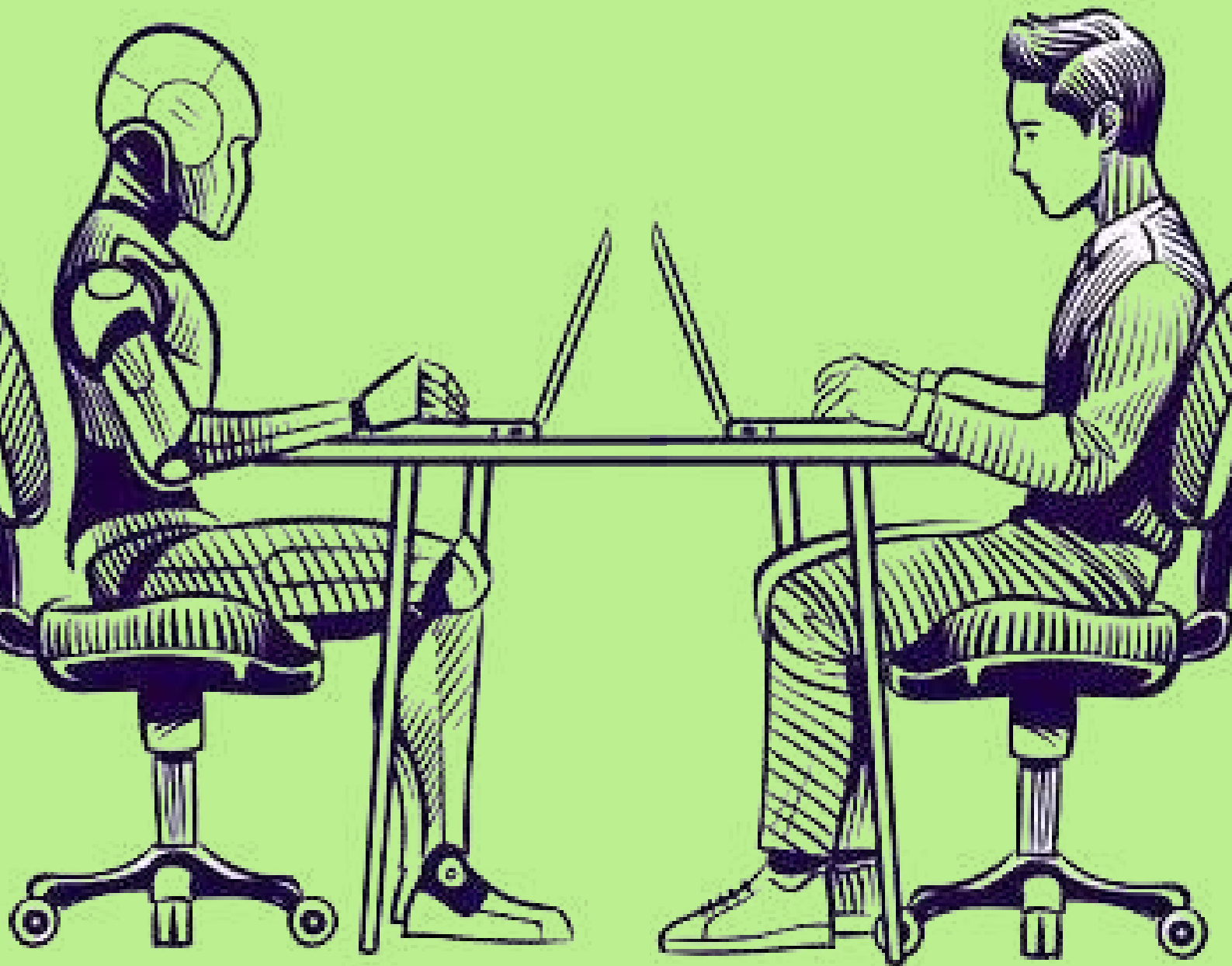





# Guarang Vishwakarma

BE ELEX STUDENT  
Founder of ALG(Arch Linux  
GUI)

1) Can you tell us about your journey about getting an internship at meta ?  
-- Since my first year I've been a part of various hackathons and went to different colleges for competitions . Techfests and other events really made me explore my creativity in the technical side. Even though I wouldn't always win , they taught me a lot .I also explored hackerank in the best possible way . In my second year, a pandemic hit and everyone was confined in their houses and I used that opportunity to explore GitHub and other sites and then I came up with my own open-source project ALG . Along with that I also started my own YouTube channel and started making videos in it . My project scaled to a great level and had 3.5 lakh users and due to that a recruiter came to me with this internship offer via LinkedIn.

2) According to you, what do you think recruiters usually see in their candidates?  
-- This really depends upon the company but they really give a lot of value to your projects ! Projects play a very important role in standing out from the crowd. If your project is creative, unique and helping the society in some way or the other , you have a better chance in getting hired

3) Can you tell us about your hiring process at META ?

-- So I was getting selected as a production engineer intern and I had 7 rounds . First four rounds were DSA rounds , two systems rounds and the other were behavioural interviews .

4) How did you push yourself to achieve this goal ?

-- The feedback that I get from my industry veterans and users all around the world have motivated me a lot in doing things . Also most importantly I've enjoyed doing such things and it has helped me to ace in different aspects .

5)What's the best part about your internship?

-- Money ! When you know about how well someone pays you it's really the best part and that in turn even motivates you to do more and be happy! Also while I was in London for my internship for 3 months we were given free accommodation,food and other amenities. Those were really the best part .

6) Would you like to give any tips for students who would like to get good internship

-- Keep brushing up your skills and keep on trying .  
Never be afraid to try something new!

# HARSH KUDTARKAR



1) About yourself, where you're currently pursuing your degree and in which subject

→ Hello, my name is Harsh Kudtarkar. I'm currently pursuing my Master's in electrical engineering with a specialization in VLSI Design from the University of Southern California Los Angeles. I graduated in 2021 from Thakur College of Engineering and Technology and later I worked as a backend Web developer in a startup named RevenueHero for ten months. I did my undergraduate electronics and telecommunication but then I jumped into software development and now I'm back again into electrical engineering.

2) What factors should I consider when choosing a country to study abroad?

→ Well for studying in abroad there isn't a single factor that is considered because it also depends on what you want to study. So if anyone wants to pursue a non-technical field so there are specific countries with a good fit for it. I personally think if we want to go for a technical field then choosing the US is good. Apart from that you also want to check your job opportunities because after you graduate you want to look for your jobs. As for me I'm pursuing electrical engineering and specializing in VLSI design, and a few semiconductor industries that I can name are Apple, Qualcomm, etc. So keeping that in my mind, I chose California for my Master's. There are other factors as well like the cost of living and the preference for climate, but these are secondary factors and these should come later. The cost of living becomes a major factor for many people who worry about higher education expenses but a good course and a good ROI pays it off.

3) How hard are the courses for you and how is it different from the regular ones which you find in India

→ Education abroad is way different than what we have been doing in India. Courses are more discussion based rather than someone teaching. The more you actively participate, the more confident you become in that course. Also, plagiarism is not tolerated and punctuality is a must. Until now, I have encountered assignments that made me think more rather than something which you can monotonously answer. Learning is more practical and design based rather than theoretical. I don't think education is tough as long as you have your undergraduate concepts cleared. What makes it harder is managing your daily chores apart from your studies. For putting it in perspective, it's more like a 9-5 job where you have to also manage your house apart from your job.

4) What are the qualifications to study abroad?

→ I don't think you need absolute qualifications to study abroad. Even a student after he completes his 10th or 12th can go for higher studies. That being said, higher education abroad, after your undergrad, requires a few entrances to be cleared. You need to give GRE for the US and Europe but not mandatory for Canada. Also, you can either give TOEFL or IELTS as your English-speaking test, although Canada only accepts IELTS.

5) Did you find any difficulties during your initial days?

→ Initially, wherever you go, you'll be hit by the cultural shift and it will take time to get comfortable with it. Settling up takes time as you don't have much idea about the area. Jet lag troubled me for a couple of days, but once you start following the daily routine, then it is no different from what you experience in India.

6) Any tips for the current batch or future batch opting for higher studies?

→ For my batch, I have seen a lot of excitement and expectations for their higher studies abroad. Some of them had started their applications late which caused a lot of stress. I would suggest all of you guys start early and be patient on every step. Being confident in your profile will eliminate anxiety about getting into your desired university. Plan your goals, do your research well and your process will go smoothly. The major step apart from your university is managing your finances and finding good roommates and a good apartment. Starting this process, as early as 6 months is highly recommended. I know sometimes we have to make close-call decisions due to various reasons like waiting for an even better university or external reasons that might delay your process. As long as you commit to the deadlines, you won't face any hurdles. All in all, start early and have a smooth process. Do your research well, because you will not get any time once you land. I wish you guys the best in your future endeavors and have fun.

Bonne chance mes amis!

## ARAVIND NAIR LECTURER



1) In what way do you think TCET has improved your child ?  
According to me, TCET has really helped my daughter in being more adaptable to different aspects of academics along with enabling her to have a versatile selection in her career choices. Their activities have helped her to be enthusiastic, creative and have good problem solving skills.

2) What's your views on the current trends in engineering?

Well computer's have really paved the way for boosting the economy and other services, other branches are not less when it comes to that either . With advancements in semiconductors, VLSI and sensors , the electronics industry is also advancing and that really makes a way for students pursuing it as a career. Places like China, USA, Taiwan are booming with their chip manufacturing and it will give various research and job opportunities to students

3) What are your expectations from the department?

So far so good , I only expect that the department stays energetic, unparalleled and effortless, trying their best to not only add up students' knowledge but also mould them to be better individuals both academically and for the rest of their lives .

4) Any tips for students ?

Follow what you like and never stop learning. The world does something new every single moment and it's very important that students be aware of it. It's also really important to have good relations with your teachers since they are the ones who would light up your path of success with their wisdom and guidance. This is the age to do something out of the box and always feel that way until you really find something that can change people's lives





# TOPPERS

---



## FIRST YEAR

GAURAV SHARMA

9.87

AYUSH DHAWAN

9.73



## THIRD YEAR

SUDHANSHU SINGH

10

AKSHAT JAIN

9.93



## SECOND YEAR

AASTHA SHARMA-ELEX

10

SHREYA SHETTY-ELEX

9.79

# the team Members

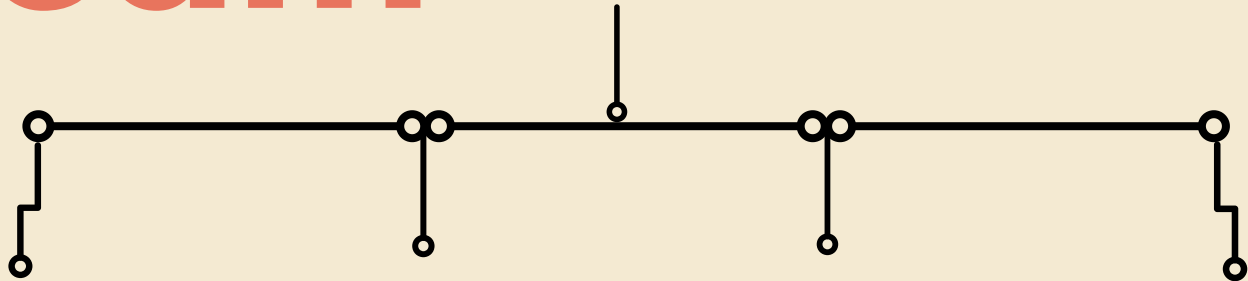

**MANSI  
VAGHASIYA**  
**CHIEF  
EDITOR**



**SHREEYA  
TIWARI**  
**CO - CHIEF  
EDITOR**



**PRUTHA  
TRIVEDI**  
**DESIGN  
HEAD**



**ARSHAD  
SYED**  
**DESIGN  
ASSOCIATE**



**ATHIRA  
ARAVIND**  
**EDITORIAL  
HEAD**



**HARSH  
SHIGWAN**  
**EDITORIAL  
HEAD**



**MAHARSHI  
THAKKAR**  
**NEWSLETTER  
HEAD**



**AMAR  
SINGH**  
**NEWSLETTER  
ASSOCIATE**

& Satyam Singh

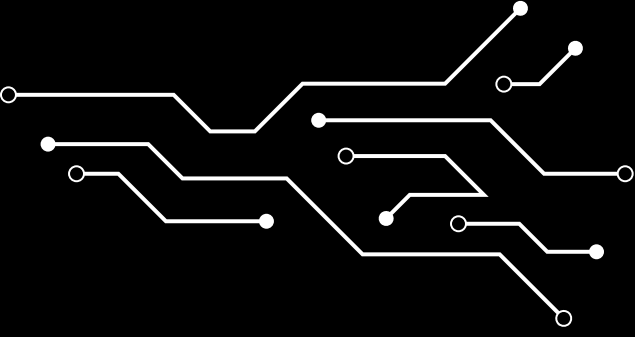

THANKYOU

